

# **S2 AND S3 SECURITY REVOLVING DOORS**

Owner's Manual

RL6003-004 – 06-2023

# Table of contents

<b>Table of contents</b>	<b>1</b>
<b>1 General Information</b>	<b>2</b>
<b>2 To Our Customers</b>	<b>2</b>
<b>3 What You Should Know</b>	<b>2</b>
3.1 Distributor Information	2
<b>4 Safety</b>	<b>3</b>
4.1 Intended Use	3
4.2 Danger Points Of The Revolving Door	3
<b>5 User Interfaces</b>	<b>4</b>
5.1 User Interfaces	4
5.2 OPL-05 Mode Keypad - Modes Of Operation	5
5.2.1 Single Release Entry/Exit	6
5.2.2 Continuous Release Entry/Exit	7
5.2.3 Unlock	7
5.2.4 Block	7
<b>6 S2 And S3 Security Door Operation</b>	<b>8</b>
6.1 S2 And S3 Security Door Operation, Standard Passage	8
6.2 S2 And S3 Security Door Operation, Unauthorized Entry In Opposite Direction	9
6.3 S2 And S3 Security Door Operation, Unauthorized Entry In Next Compartment	10
6.4 S3 Security Door Operation, Anti-piggybacking	11
6.5 S2 And S3 Security Door Operation, Push To Reverse Buttons	12
<b>7 S3 Security Door Assembly Examples</b>	<b>13</b>
7.1 S2 And S3 Security Door Assemblies	13
7.2 Door Wing Example	16
7.3 Door Wing Types	16
7.4 Shaft And Bookfold Lock Assembly	17
<b>8 Maintenance</b>	<b>18</b>
8.1 Door and Floor Maintenance	18
8.2 Weathersweeps	18
8.3 Shaft Assembly Floor Bearing	19
8.4 Cleaning surfaces	20

# 1 General Information

## 1.1 S2 and S3 security revolving doors.

Revolving door that prevents unauthorized access and minimizes impact on traffic flow (Reference Chapter 6).

### 1.1.1 S2 security door with anti-tailgating.

- Anti-tailgating prevents unauthorized access in the opposite direction and in the next chamber.

### 1.1.2 S3 security door with anti-tailgating and anti-piggybacking.

- Anti-tailgating prevents unauthorized access in the opposite direction and in the next chamber.
- Anti-piggybacking restricts access to a single confirmed person.

## 1.3 Owner's Manual

This Owner's manual applies to Alvarado S2 and S3 security revolving doors.

## 1.4 Manual storage.

This document must be kept in a secure place, and accessible for reference as required.

## 1.5 Dimensions

Unless otherwise specified, all dimensions are given in inches (").

## 1.6 Symbols used in this manual.



### WARNING

This symbol warns of hazards which could result in personal injury or threat to health.

### CAUTION

Warns of a potentially unsafe procedure or situation.



### TIPS AND RECOMMENDATIONS

Clarifies instructions or other information presented in this document.

# 2 To Our Customers

We are pleased that an Alvarado S2 or S3 security revolving door has been selected for this installation.

The purpose of this manual is to provide you information regarding your Alvarado S2 or S3 security revolving door. This includes safety, S2 and S3 security operation and maintenance information.

It is essential that you recognize the importance of maintaining your door.

**It is your responsibility** as owner and caretaker of the equipment, to inspect the operation of your door system to insure that it is safe for use by your customers and employees.

Call your local Alvarado distributor for repair. The distributor is trained to service the revolving door using the applicable Alvarado Installation Manual.

### Service availability.

Alvarado has a nationwide network of authorized distributors for sales, installation and service of its products.

# 3 What You Should Know

## 3.1 Distributor Information

### 3.1.1 Alvarado distributor information.

Be sure that the Alvarado distributor has provided the following information for each door installation:

1. Alvarado Owner's Manual RL6003-004.
2. Review of S2 and S3 user interfaces (Chapter 5) and S2 and S3 security door operation (Chapter 6).
3. Discussion of problems that could result from door operation after a malfunction observed.

4. Number to call for service or questions about your revolving door if you are uncertain of any condition or situation.
5. Location of job number tag on door center shaft assembly (Reference Chapter 7, Fig. 7.4.1).



### WARNING

If there are any problems, discontinue door operation immediately and secure the door in a safe manner.  
Call your local Alvarado distributor for repair.

# 4 Safety

## 4.1 Intended Use

### 4.1.1 Intended use.

- The S2 and S3 security 4 wing revolving doors are designed to provide limited access for pedestrian traffic between two separate areas.
- **Security doors are intended for use only by personnel trained in their proper use.**
- When a bookfold turnstile is used, the revolving door can be used as an emergency exit.



#### WARNING

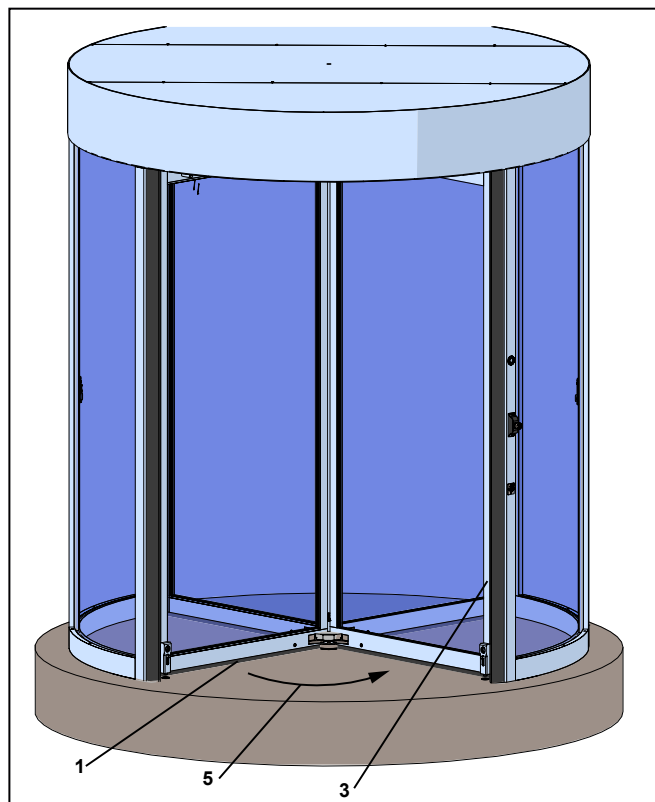
In case of emergency, revolving door can be used as an exit, but it is not the primary path of egress. The side door(s) should be used!

- **The customer can only operate the revolving door after door commissioning and training by Alvarado service technicians.**

## 4.2 Danger Points Of The Revolving Door

When passing through the revolving door, people may be at risk for injury at the following locations in Fig. 4.2.1.

Fig. 4.2.1 Revolving door danger points



#### WARNING

Danger of misuse!

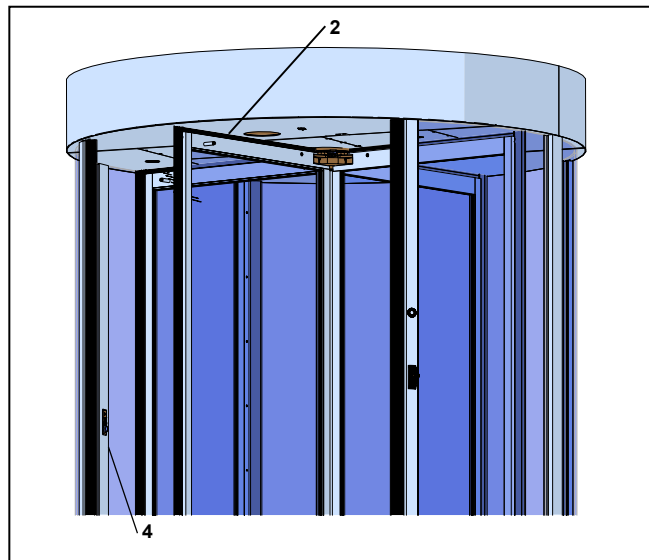
Misuse of the revolving door can cause dangerous situations.

- Never mount or hang objects on the revolving door.
- Never stop or block the revolving door with an object.
- Do not walk through the revolving door with bulky objects.
- Do not walk against the wing rotation direction of the revolving door.
- Do not operate the revolving door if there is insufficient lighting.
- Do not operate the revolving door if it is damaged (e.g., broken glass).
- Never use replacement parts that are not approved by Alvarado.

TABLE 4.2.1 Revolving door danger points

1	Secondary closing edge, floor
2	Secondary closing edge, canopy
3	Opposing closing edge
4	Main closing edge, inner wall
5	Wings rotate in a counterclockwise direction

Fig. 4.2.1 Revolving door danger points



# 5 User Interfaces

## 5.1 User Interfaces

### 5.1.1 Door user interfaces, interior view.

Fig. 5.1.1 S2 and S3 door assembly user interfaces, interior view

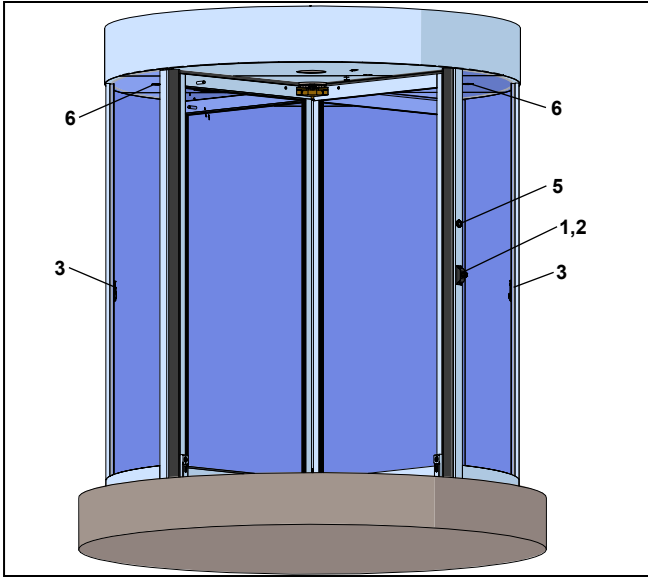


TABLE 5.1.1 Door user interfaces

ID#	Function
1	Switch, Emergency Stop
2	Housing, Emergency Stop switch
3	Switch panel assembly, Push to Reverse
5	Activation light
6	Voice module speaker
7	Card reader, by others

Fig. 5.1.2 Push to reverse jamb pushplate

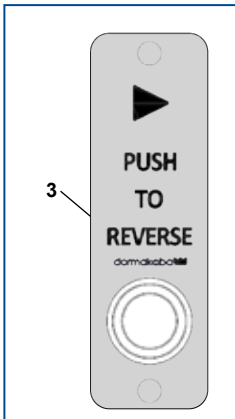


Fig. 5.1.3 Card reader example- by others



Fig. 5.1.4 Activation light

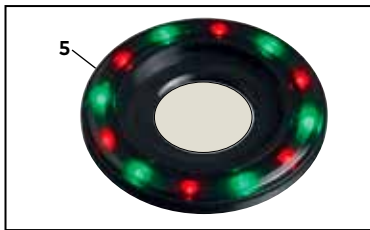


Fig. 5.1.5 Speaker, canopy mounted

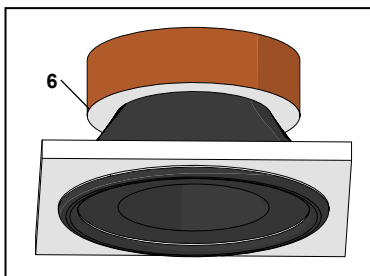


Fig. 5.1.6 K9 OPL05 mode key switch

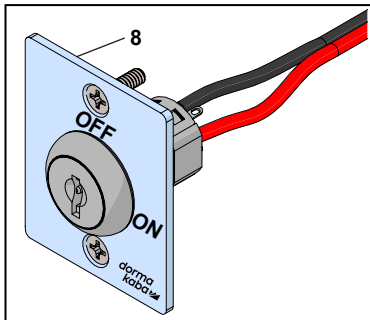


Fig. 5.1.7 Emergency stop pushbutton and housing

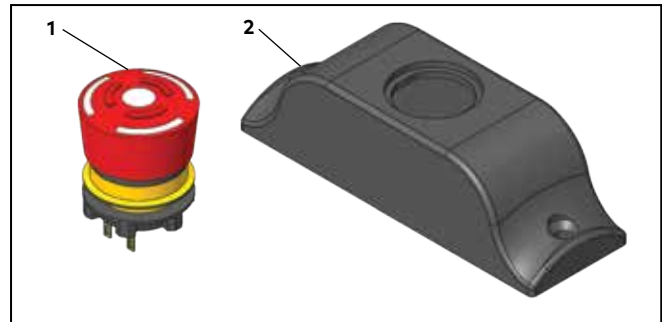
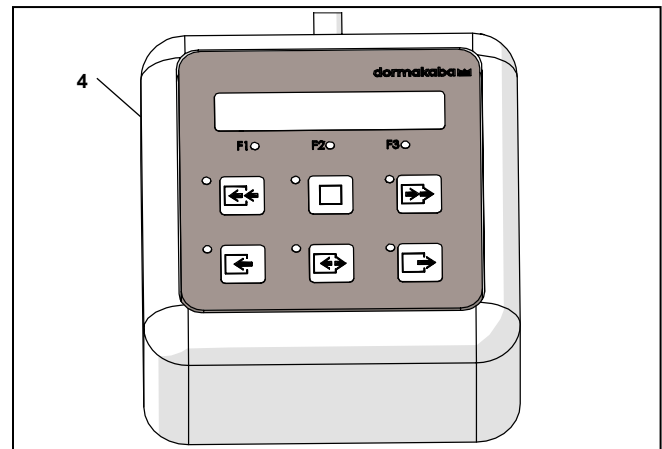


Fig. 5.1.8 K9 OPL05 mode keypad



### TIPS AND RECOMMENDATIONS

**K9 OPL 05 mode keypad (4) and keyswitch (8).** Mounted and wired by installer at door installation.

## 5.2 OPL-05 Mode Keypad – Modes Of Operation

Fig. 5.2.1 OPL-05 Mode keypad

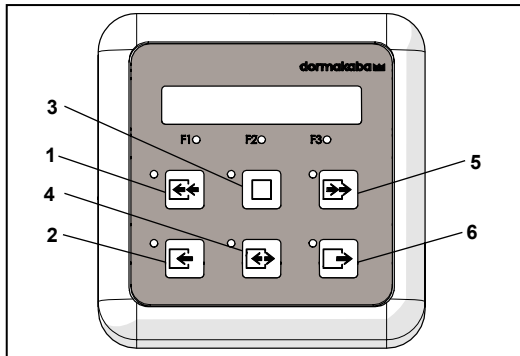


Table 5.2.1 OPL-05 modes of operation

	Symbol	Description
5		Continuous release exit Persons can pass in the exit direction without authentication / card read.
6		Single release exit Persons required to present a credential for each exit.
3		Block Wings rotate to home position and block. K9 locking bolts engage. Block removed with a Continuous or Single Release command.
4		General release The drive is in the home position. The door wings can be moved freely. Cleaning and manual locking is possible. Function can be overridden with Block.
1		Continuous release entry Persons can pass in the entry direction without authentication / card read.
2		Single release entry Persons required to present a credential for each entry.

### 5.2.1 Activation light.

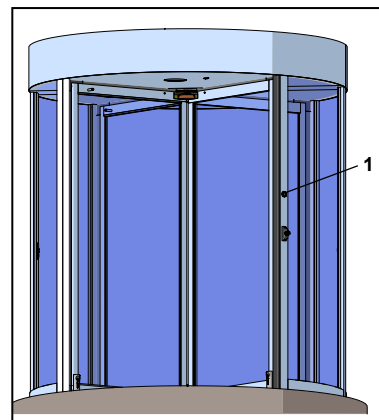
1. Illuminated green:  
passage enabled.



2. Illuminated red:  
passage not released.

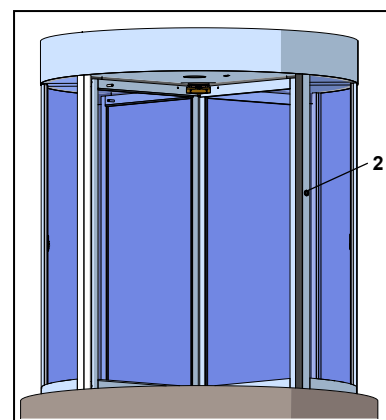


Fig. 5.2.2 Interior activation light



1 Interior activation light

Fig. 5.2.3 Exterior activation light




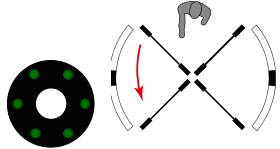
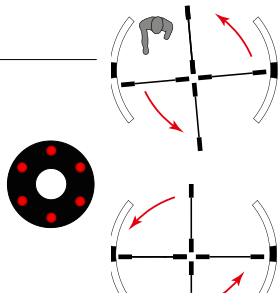

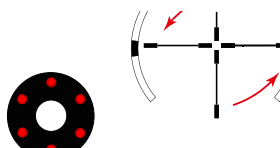
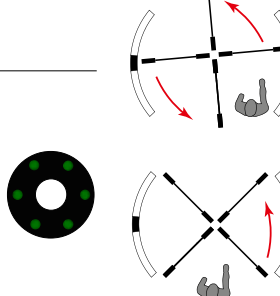
2 Exterior activation light

## 5.2.1 Single Release Entry/Exit

### 5.2.1.1 Single release entry/exit.

1. Single release entry: applies to passage from outside to inside of the building.
2. Single release exit: applies to passage from inside to outside of the building.
3. Activation: A person requests a single release via:
  - Card reader
  - OPL
  - Release button

Table 5.2.1.1 Single release Entry/Exit







Symbol	Description	Activation light	Diagram	Description
	Single release entry	Exterior (Green)		<ul style="list-style-type: none"> <li>• Persons required to present a credential for each entry.</li> </ul>
	<ul style="list-style-type: none"> <li>• Outside of building to inside</li> </ul>	Interior (Red)		
	Single release exit	Exterior (Red)		<ul style="list-style-type: none"> <li>• Persons required to present a credential for each exit.</li> </ul>
	<ul style="list-style-type: none"> <li>• Inside of building to outside</li> </ul>	Interior (Green)		

## 5.2.2 Continuous Release Entry/Exit

### 5.2.2.1 Continuous release entry/exit.

1. Activation:by OPL.

Table 5.2.2.1 Continuous release entry/exit



Symbol	Description	Activation light	Diagram	Description
	<p>Continuous release entry</p> <ul style="list-style-type: none"> <li>• Outside of building to inside</li> </ul>	Exterior (Green)		<ul style="list-style-type: none"> <li>• Persons can pass in the entry direction with authentication/card read.</li> </ul>
		Interior (Red)		
	<p>Continuous release exit</p> <ul style="list-style-type: none"> <li>• Inside of building to outside</li> </ul>	Exterior (Red)		<ul style="list-style-type: none"> <li>• Persons can pass in the exit direction with authentication/card read.</li> </ul>
		Interior (Green)		

## 5.2.3 Unlock

### 5.2.3.1 Unlock

1. Activation by OPL.

Table 5.2.3.1 Unlock



Symbol	Description	Activation lights	Diagram	Description
	Unlock	(Green)		<p>Unlocks only if door is not blocked.</p> <ul style="list-style-type: none"> <li>• The drive switches off.</li> <li>• Door wings can be freely rotated, e.g. for cleaning purposes or manual locking of the door wings.</li> </ul>

## 5.2.4 Block

### 5.2.4.1 Block

1. Activation:by OPL.

Table 5.2.4.1 Block

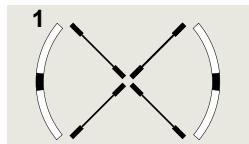
Symbol	Description	Activation lights	Diagram	Description
	Block	(Red)		<ul style="list-style-type: none"> <li>• Wings rotate to home position and block.</li> <li>• K9 locking bolts engage.</li> <li>• Block removed with a Continuous or Single Release command..</li> </ul>



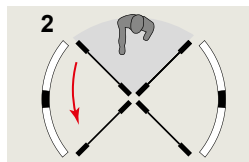
# 6 S2 And S3 Security Door Operation

## 6.1 S2 And S3 Security Door Operation, Standard Passage

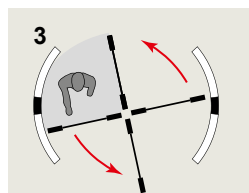
### 6.1.1 S2 and S3 security – standard passage.



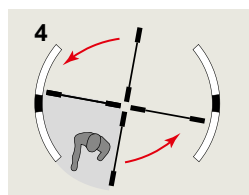
1. Door shall be normally locked in the "X" position
  - Door indicator light illuminated red.



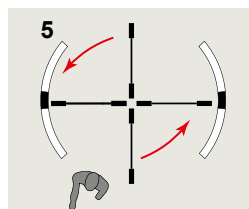
2. Upon receipt of a valid signal from the card reader:
  - Door indicator light illuminates green.
  - Annunciator voice message will prompt the user to enter the door.



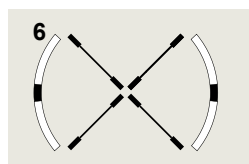
3. When the entry point sensor detects a user while the door indicator is green, the door will start rotating forward (CCW), or continue rotating if it is already in motion from previous cycle.
  - The overhead presence sensor detects the person. The controller identifies the validity of the access and allows door to continue the cycle.



4. Person exits the door.



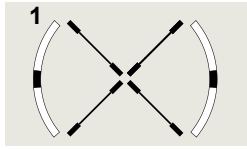
5. Door rotation speed slows down as it nears completion of its cycle and approaches the "X" position.



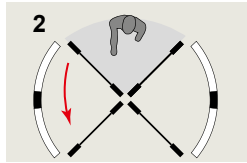
6. At the end of the cycle, the door stops and securely locks at the next ("X") position.
  - Door indicator light illuminates red.

## 6.2 S2 And S3 Security Door Operation, Unauthorized Entry In Opposite Direction

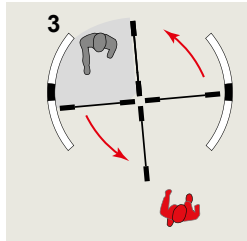
### 6.2.1 S2 and S3 security – unauthorized access in the opposite direction.



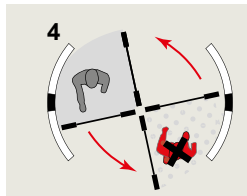
1. Door shall be normally locked in the "X" position.
  - Door indicator lights illuminated red.



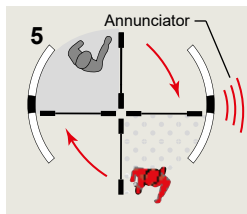
2. Upon receipt of a valid signal from the card reader
  - Door indicator will illuminate green.
  - Annunciator voice message will prompt the user to enter the door.



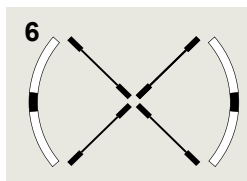
3. When the entry point sensor detects a user while the door indicator is green, the door will start rotating forward (CCW), or continue rotating if it is already in motion from previous cycle.



4. Attempted passage through an unauthorized area from the other side of the door without presenting a valid card signal will result in the door being stopped by the drive.



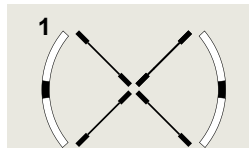
5. The annunciator will inform the user of an unauthorized person and that the door will reverse.
  - The door then reverses to the closest "+" position and stops rotating. Both pedestrians step out of the door.



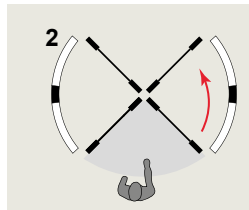
6. When the presence of the unauthorized person at the entrance is no longer detected (Step 4), the door will resume rotating in the forward direction and will securely lock at the next "X" position.
  - Door indicator lights illuminated red.

## 6.3 S2 And S3 Security Door Operation, Unauthorized Entry In Next Compartment

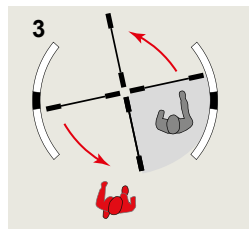
### 6.3.1 S2 and S3 security – unauthorized access in the next compartment (anti-tailgating).



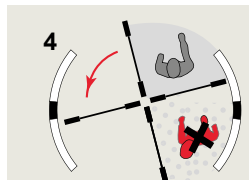
1. Door shall be normally locked in the "X" position.
  - Door indicator lights illuminated red.



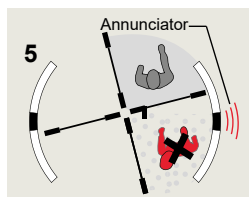
2. Upon receipt of a valid signal from the card reader:
  - Door indicator will illuminate green.
  - Annunciator voice message will prompt the user to enter the door.



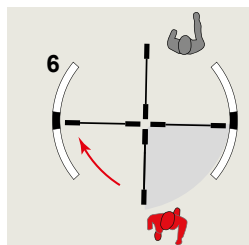
3. When the entry point sensor detects a user while the door indicator is green, the door will start rotating forward (CCW), or continue rotating if it is already in motion from previous cycle.



4. Intruder enters next available compartment.

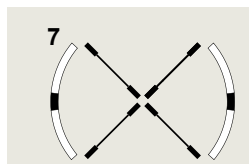


5. Entry point and presence sensors detect intruder's presence.
  - The door stops.
  - The annunciator will inform the user of an unauthorized person and that the door will reverse.



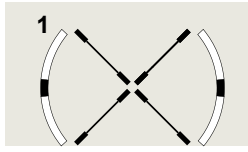
6. The door then reverses to the closest "+" position and stops, allowing the user to complete the authorized entry and the unauthorized person to clear the secured area.

7. When the presence of the unauthorized person at the entrance is no longer detected, the door will resume rotating in the forward direction and will securely lock at the next "X" position.
  - Door indicator lights illuminated red.

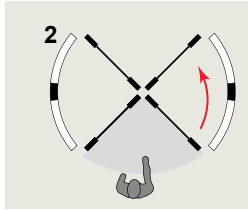


## 6.4 S3 Security Door Operation, Anti-piggybacking

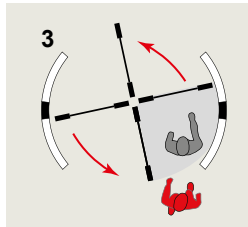
### 6.4.1 S3 security – Anti-piggybacking



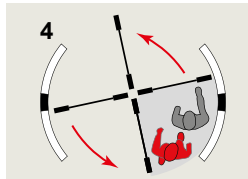
1. Door shall be normally locked in the "X" position.
  - Door indicator lights illuminated red.



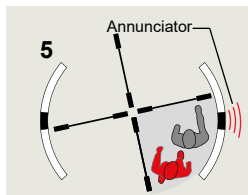
2. Upon receipt of a valid signal from the card reader:
  - Door indicator will illuminate green.
  - Annunciator voice message will prompt the user to enter the door.



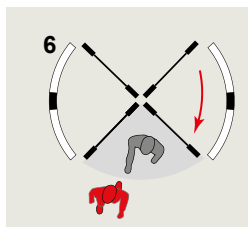
3. When the entry point sensor detects a user while the door indicator is green, the door will start rotating forward (CCW), or continue rotating if it is already in motion from previous cycle.



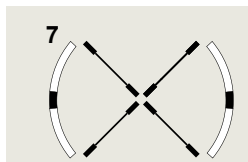
4. Intruder follows in same compartment.



5. Security sensor detects intruder's presence.
  - The door stops.
  - The annunciator will inform the user of an unauthorized person and that the door will reverse.



6. The door then reverses to the closest "+" position and stops, allowing both occupants to clear the compartment.

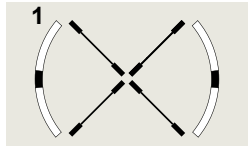


7. When the presence of the unauthorized person at the entrance is no longer detected, the door will resume rotating in the forward direction and will securely lock at the next "X" position.
  - Door indicators illuminate red.

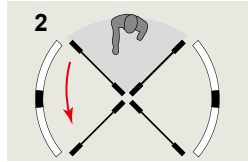
## 6.5 S2 And S3 Security Door Operation, Push To Reverse Buttons

### 6.5.1 S2 and S3 security – Push to Reverse button operation.

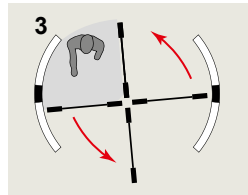
A Push to Reverse button is located on the interior side of each center post.



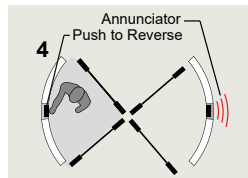
1. Door shall be normally locked in the "X" position.
  - Door indicator lights illuminated red.



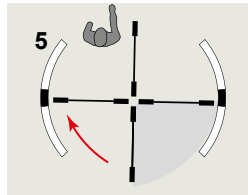
2. Upon receipt of a valid signal from the card reader:
  - Door indicator will illuminate green.
  - Annunciator voice message will prompt the user to enter the door.



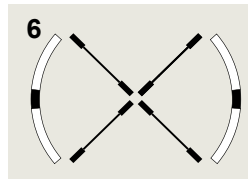
3. When the entry point sensor detects a user while the door indicator is green, the door will start rotating forward (CCW), or continue rotating if it is already in motion from previous cycle.



4. User presses Push to Reverse button:
  - Door stops.
  - The annunciator will inform the user that the door will reverse.



5. The door then reverses to the closest ("+") position and stops rotating. User steps out of the door.



6. When the user has exited the revolving door (Step 5), the door will resume rotating in the reverse direction and will securely lock at the next "X" position.
  - The controller will not accept new requests to pass while the door is rotating in the reverse direction.
  - Door indicators illuminated red.

Fig. 6.5.1 Push to Reverse Fig. 6.5.2 S2 and S3 security door Push to Reverse buttons

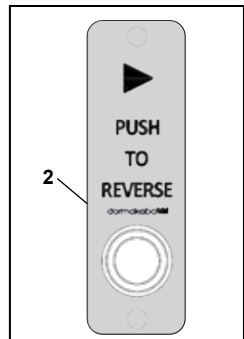
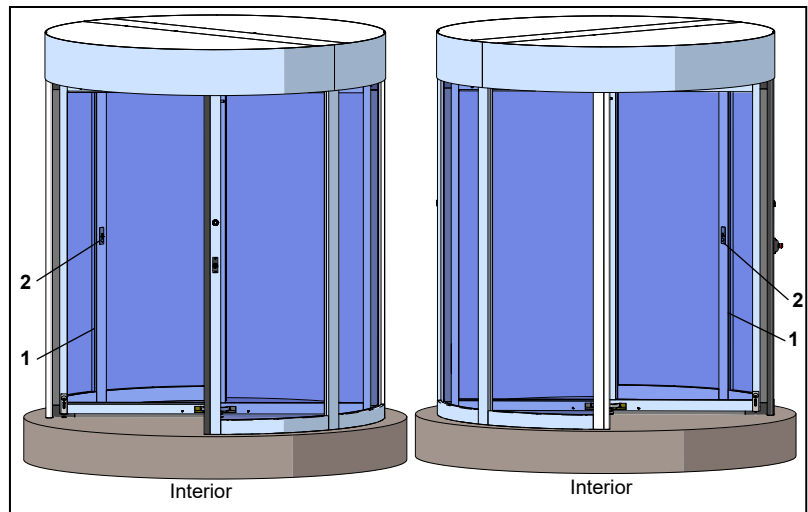


Table 6.5.1 Push to Reverse switch plate

1	Center post
2	Push to Reverse switch assembly



# 7 S3 Security Door Assembly Examples

## 7.1 S2 And S3 Security Door Assemblies

Fig. 7.1.1 Four wing security revolving door assembly

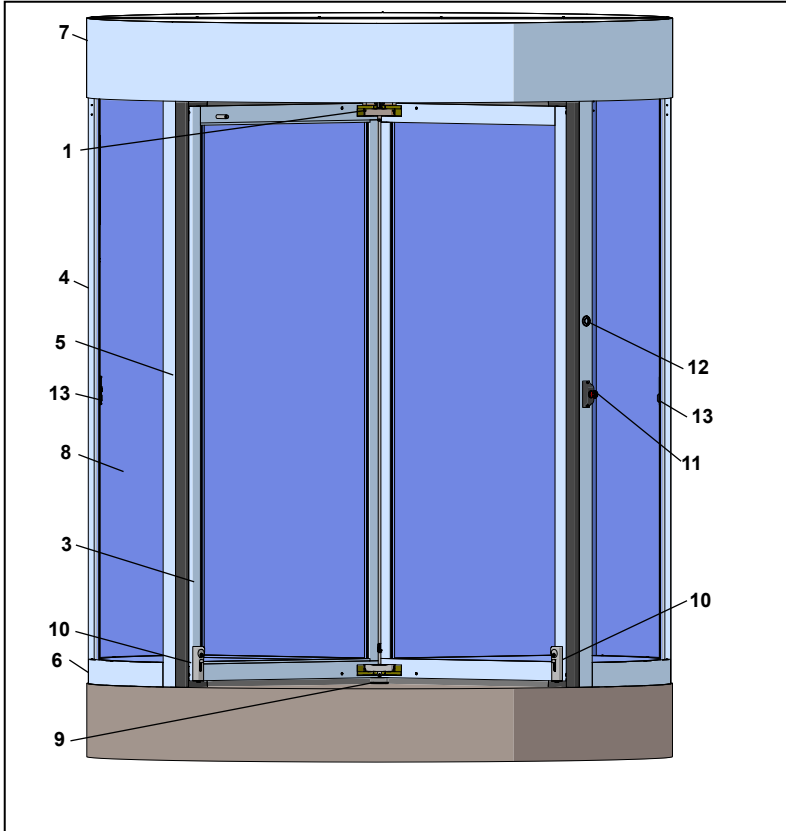


Fig. 7.1.2 Wing assembly

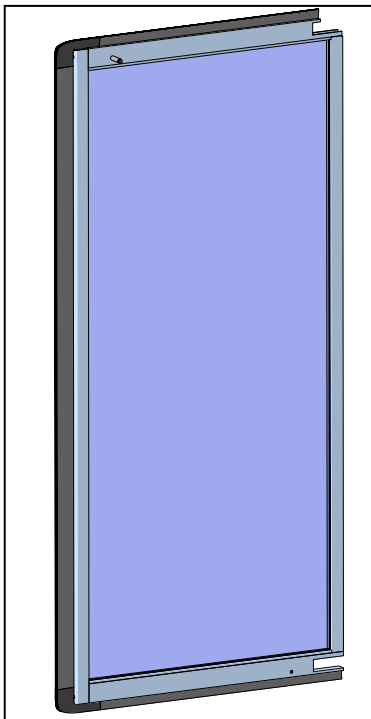


Fig. 7.1.3 Enclosure glass

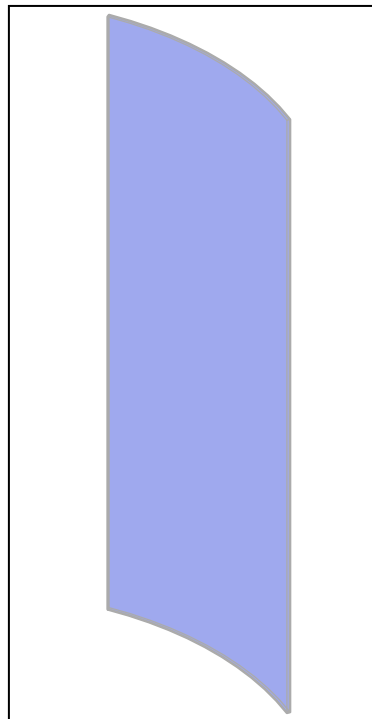


Table 7.1.1 S2 and S3 security door assembly

1	Shaft with bookfold lock assembly
3	Wing assembly
4	Enclosure center post
5	End wall and bumper assembly
6	Bottom rail and cover assembly
7	Canopy assembly
8	Enclosure glass
9	Bearing assembly
10	Surface lock assembly
11	Emergency stop
12	Activation light
13	Push to Reverse switch assembly

Fig. 7.1.4 Shaft assembly, end wall/bumper assembly and center post

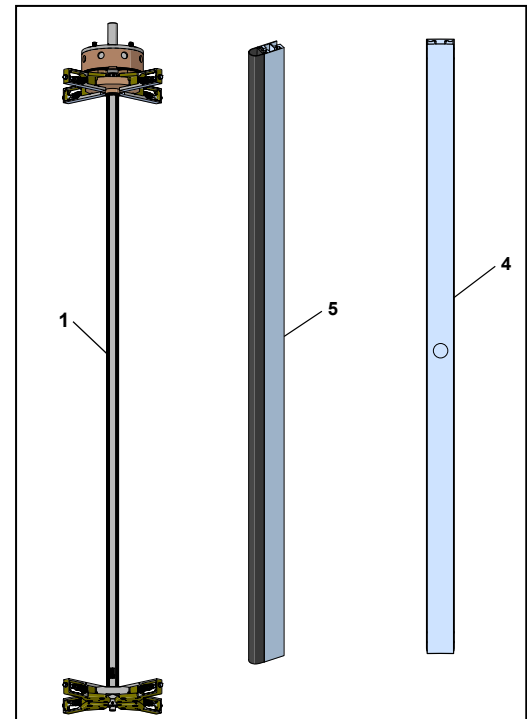


Fig. 7.1.5 Bottom rail and cover assembly

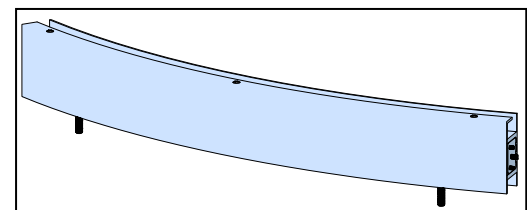


Table 7.1.2 S3 security door and canopy assembly

4	Starting sensor, outside, TOFNiva
5	Presence sensor, outside, Intenta
6.1	Presence sensor, inside, TOFNiva
6.2	Presence sensor, inside, Intenta (Option)
7	Starting sensor inside, TOFNiva
8	Voice module speaker
9	LED light (option)

Fig. 7.1.6 S3 security canopy soffit view, 1 Intenta sensor, outside

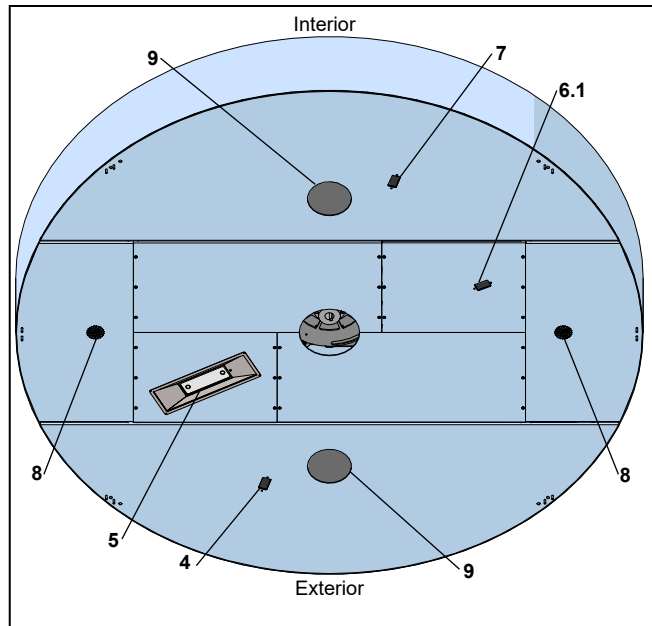


Fig. 7.1.7 S3 security canopy soffit view, 2 Intenta sensors, outside and inside (option)

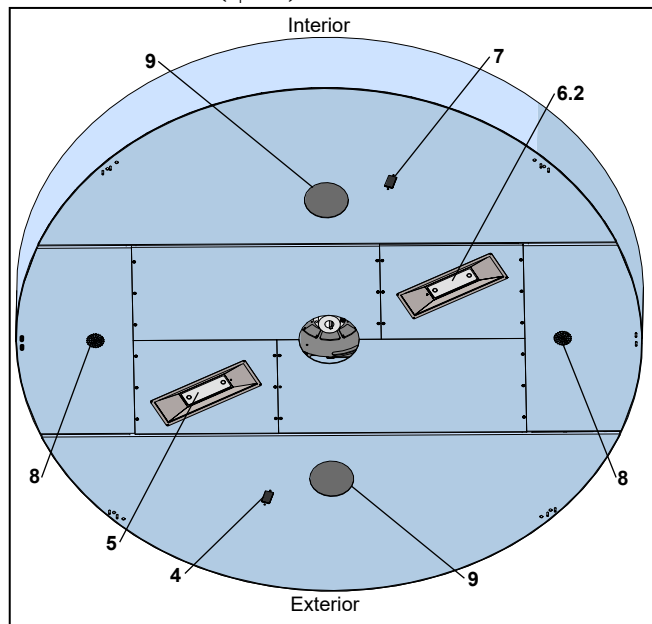


Fig. 7.1.8 S3 security door, 1 Intenta sensor, ingress

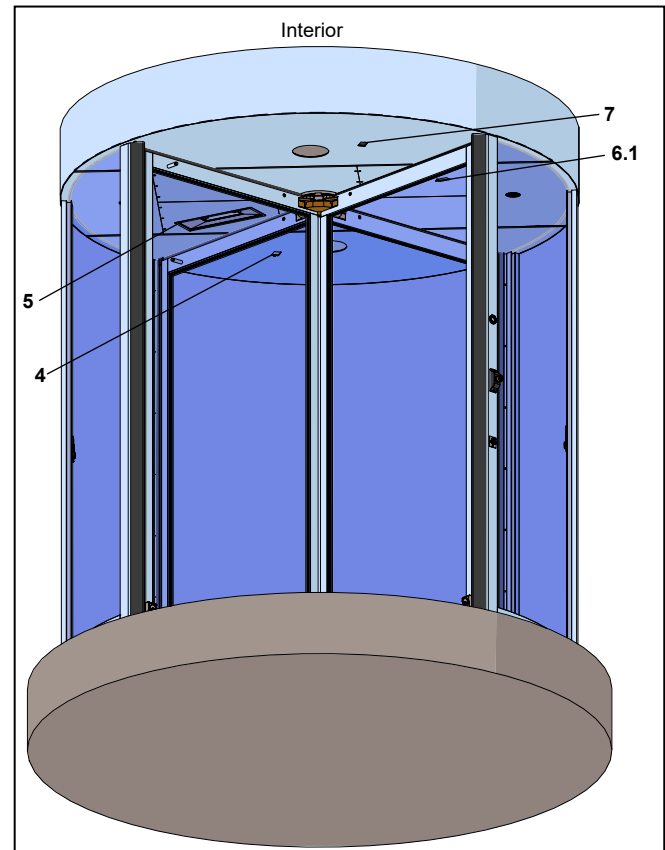


Fig. 7.1.9 S3 security door, 2 Intenta sensors, ingress and egress (option)

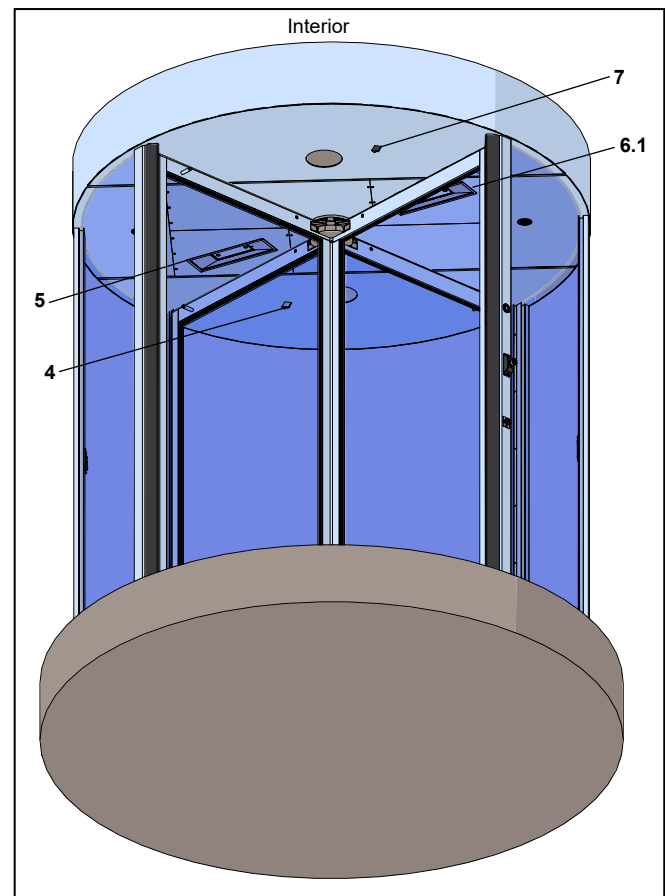


Table 7.1.3 S2 security door and canopy assembly

4	Starting sensor, outside, TOFniva
5	Presence sensor, outside, TOFniva
6	Presence sensor, inside, TOFniva
7	Starting sensor, inside, TOFniva
8	Voice module speaker
9	LED light (option)

Fig. 7.1.10 S2 security canopy soffit view

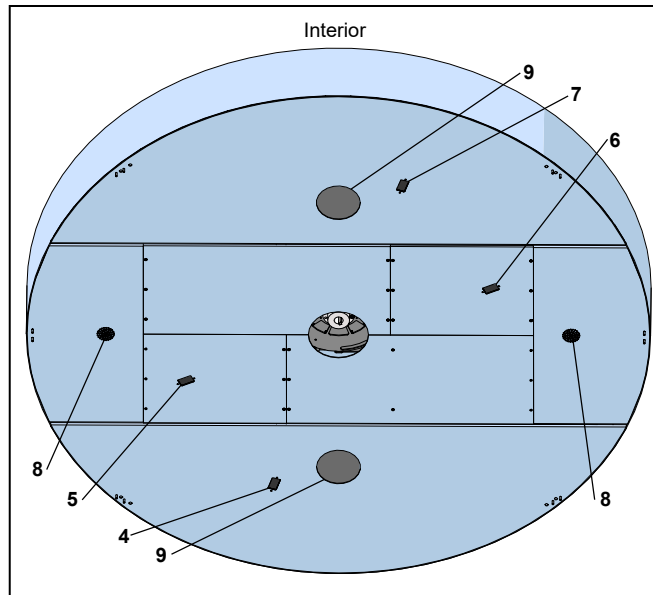
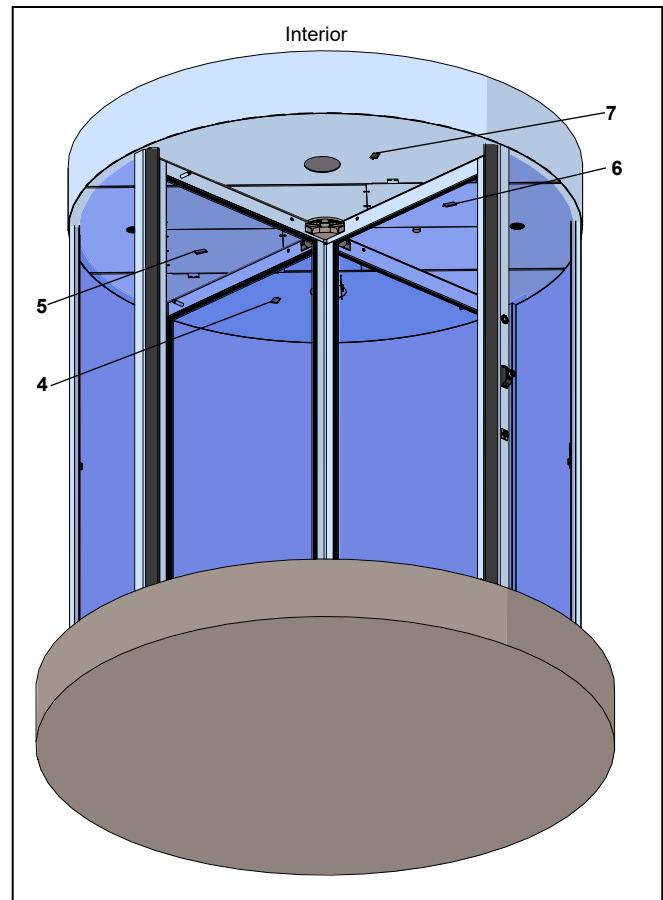


Fig. 7.1.11 S2 security door canopy sensors





## 7.2 Door Wing Example

Fig. 7.2.1 Aluminum 4 wing assembly

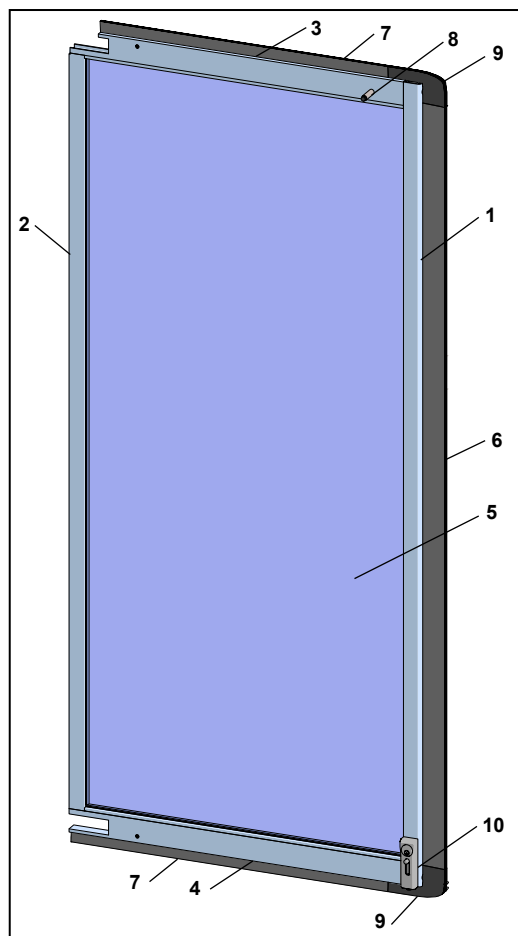
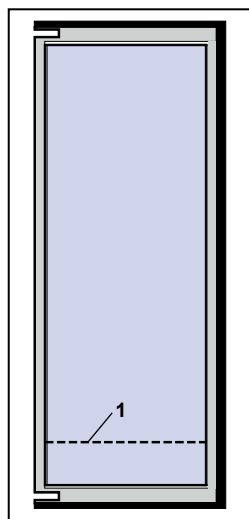


Table 7.2.1 Aluminum 4 wing assembly

1	Wing outer extrusion, flush bolt
2	Wing center extrusion
3	Wing top extrusion
4	Wing bottom extrusion
5	Wing glass
6	Sweep brush vertical
7	Sweep brush horizontal
8	Wing bumper assembly
9	Sweep brush corner
10	Surface lock with lock cylinder (by others)

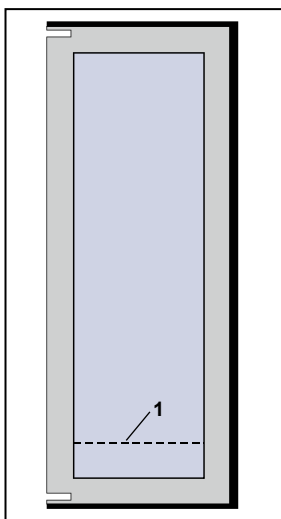
## 7.3 Door Wing Types

Fig. 7.3.1 Narrow stile



1 Optional tall bottom rail

Fig. 7.3.2 Medium & Wide stile



1 Optional tall bottom rail

Fig. 7.3.3 Patch fitting

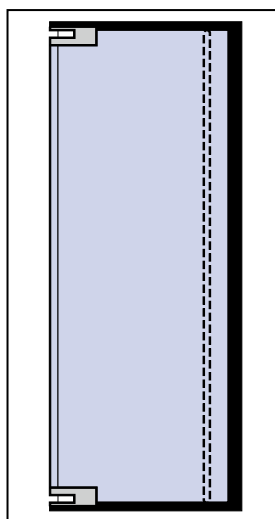
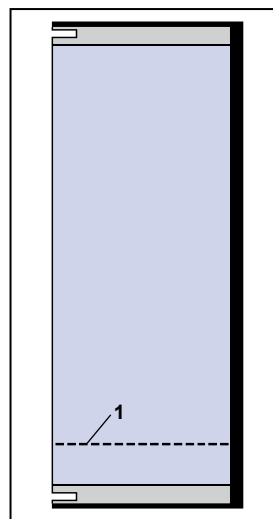


Fig. 7.3.4 Herculite



1 Optional tall bottom rail

## 7.4 Shaft And Bookfold Lock Assembly

### 7.4.1 Bookfold Lock Overview.

1. Bookfold lock is normally engaged, increasing the force to bookfold wings.
2. Bookfold lock is released when:
  - Fire alarm is present.
  - Emergency stop pushbutton activated.
  - Power is off.

Fig. 7.4.1 Shaft assembly with bookfold lock

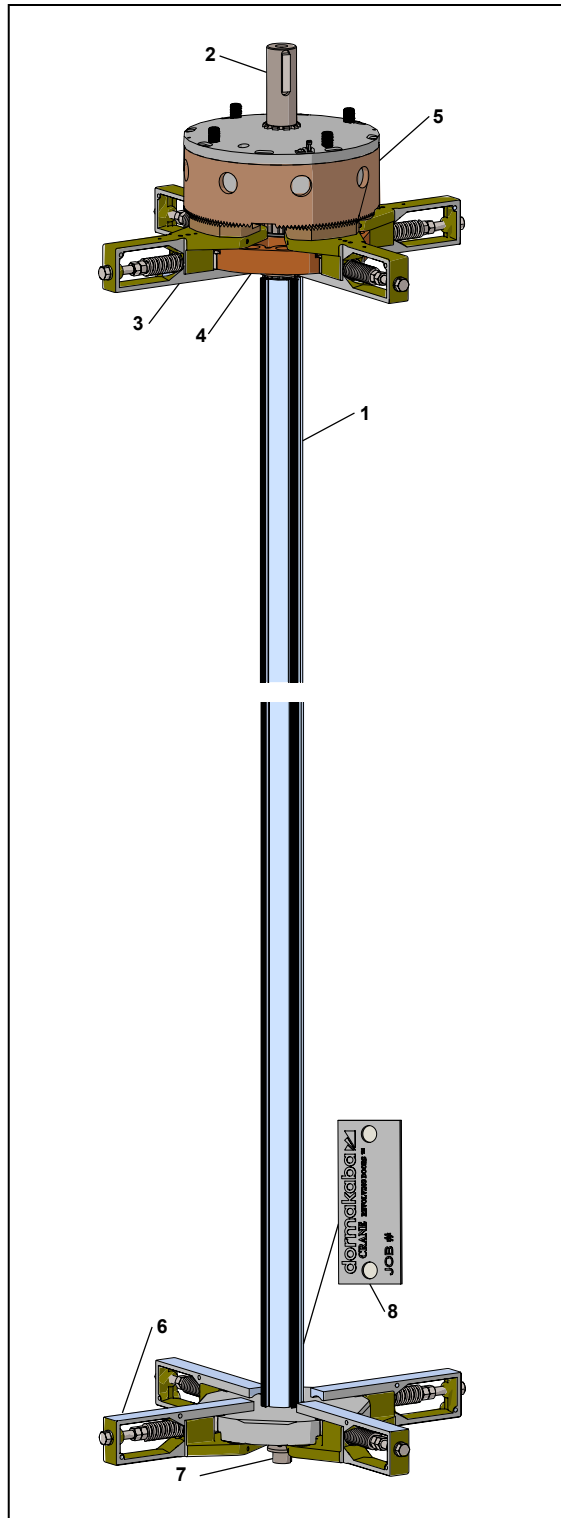
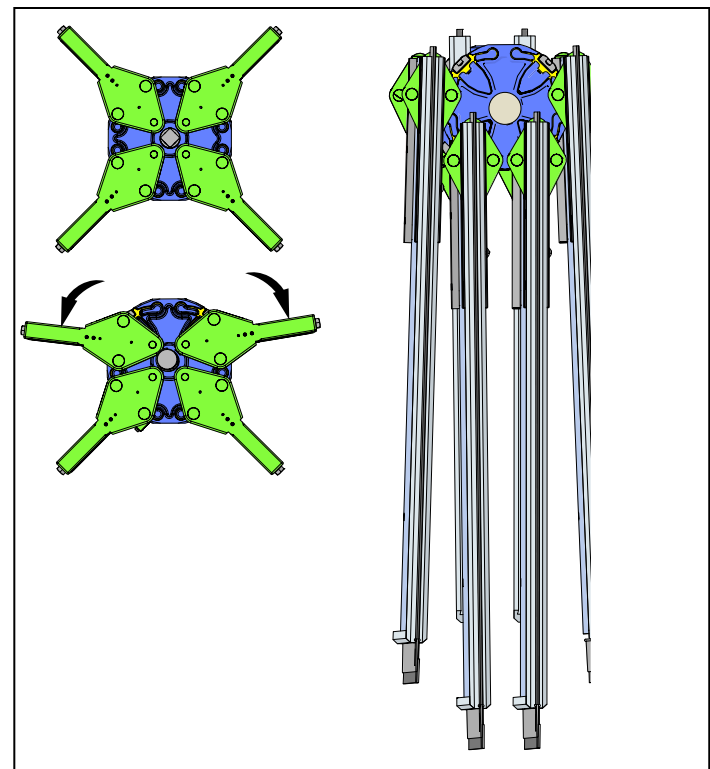


Table 7.4.1 Shaft with bookfold lock assembly

1	Shaft assembly
2	Splined shaft
3	Top hanger assembly with AB hanger for bookfold lock
4	Center shaft disc assembly, 4 wing
5	Bookfold lock assembly
6	Bottom hanger assembly
7	Bottom plug
8	Nameplate/job number tag

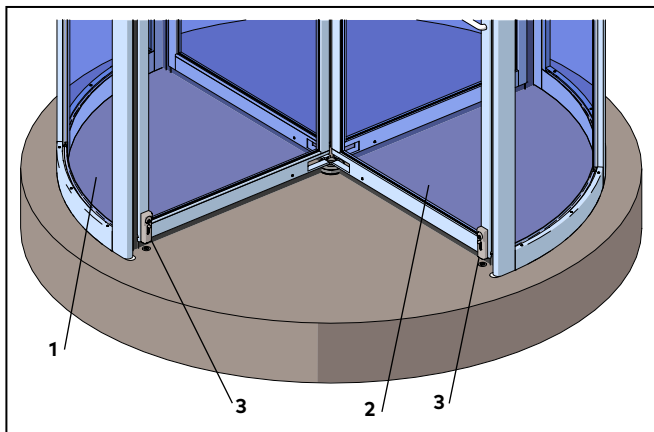
Fig. 7.4.2 Wings in bookfold position



# 8 Maintenance

## 8.1 Door and Floor Maintenance

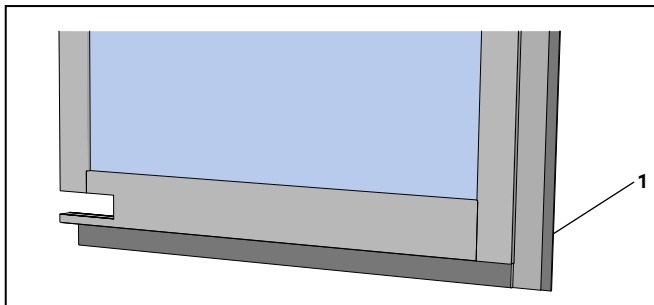
Fig. 8.1.1 4 wing revolving door



- 1 Enclosure glass
- 2 Wing glass
- 3 Surface lock and floor strike

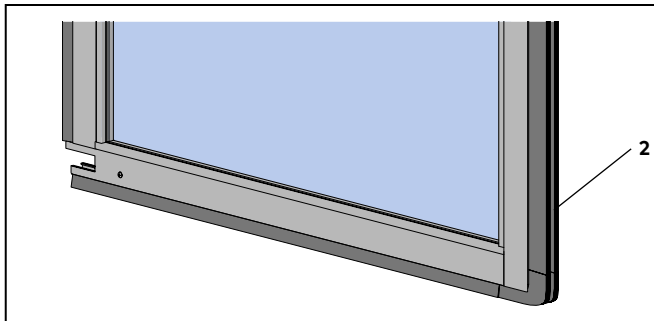
## 8.2 Weathersweeps

Fig. 8.2.1 T-style weathersweep



- 1 T-style weathersweep

Fig. 8.2.2 Horsehair weathersweep



- 2 Horsehair weathersweep

### 8.1.1 Floor maintenance.

1. Keep floor surface clean and free of dirt and debris.

### 8.1.2 Mechanical surface locks and floor strikes.

1. Keep surface locks and floor strikes free of dirt and debris.

### 8.1.3 Door glass maintenance.

1. Keep all glass surfaces clean.
- Clean glass surfaces with commercially available glass cleaners.

### 8.2.1 Weathersweep maintenance.

**NOTICE**

Reducing or trimming the size of the bottom sweep makes the sweep more rigid and voids all warranties.

1. Inspect condition of sweeps.
- Recondition horsehair sweeps if possible using conditioner.
2. Replace weathersweeps as required.
- Contact Alvarado for replacement weathersweeps.

## 8.3 Shaft Assembly Floor Bearing

Fig. 8.3.1 Surface mounted bearing

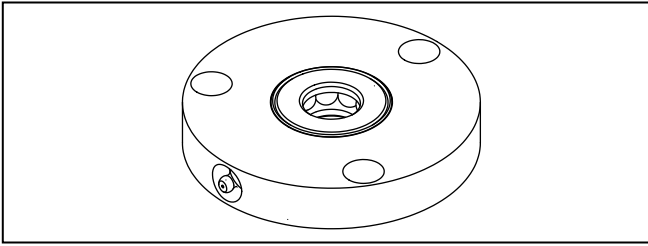
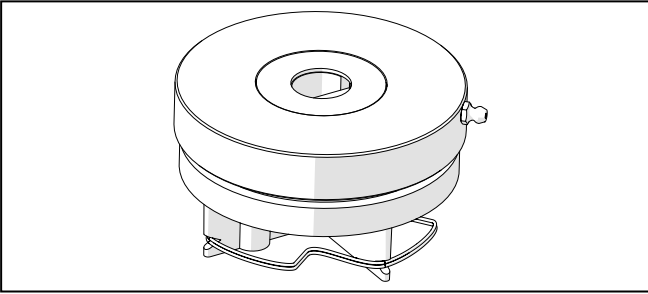


Fig. 8.3.2 In-ground bearing



### 8.3.1 Bearing lubrication.

1. Grease pivot bearing semiannually.



#### TIPS AND RECOMMENDATIONS

Use general multipurpose grease.

### 8.3.2 Cleaning bearing/center shaft.

1. Clean surface area at bearing/center shaft of dirt and debris as required.

## 8.4 Cleaning surfaces

### 8.4.1 Aluminum

1. Dust and grime can be removed by regular cleaning.
  - Use a mild, non-abrasive soap or cleaning solution and water.
  - After cleaning, surfaces should be wiped dry with a clean absorbent material.
2. Tar and built-up dirt can be removed with solvent cleaners such as turpentine if followed by a soap and water cleaning and fresh water rinse.

#### NOTICE

Avoid acid or alkali cleaners; they may attack the anodized finish.

- After cleaning, surfaces should be wiped dry with a clean absorbent material.

### 8.4.2 #4 stainless steel.

1. For routine cleaning, use soap, ammonia, or detergent and water.
  - Always working in the direction of the grain, rub with a sponge or rag.
  - Rinse with water, wipe dry.
2. Stubborn dirt or grime can be removed with a quality commercial stainless steel cleaner.

### 8.4.3 Mirror finish stainless steel.

#### NOTICE

Mirror finishes require very special care. Abrasive cleaners and cloths should never be used.

1. Use only mild soap and water or glass cleaner.
  - After cleaning, surfaces should be wiped dry with a clean absorbent material.

### 8.4.4 Bronze

#### NOTICE

To insure proper maintenance, consult a professional bronze finisher and establish a regular metal cleaning program.

1. Bronze finishes are protected during shipping and installation by a shop coat of lacquer.

#### NOTICE

Lacquer can be damaged by ammonia in window cleaners, or by acids from masonry cleaners. Protect doors from these cleaners.

#### NOTICE

Doors must be inspected and worked after installation by a qualified bronze finisher.

### 8.4.5 Painted finishes.

1. Any mild non-abrasive soap or mild solvent can be used for cleaning.

#### NOTICE

Strong solvents may dissolve paint. Test any solvent first.

2. Wax can be used to protect the finish.

